

REACH & RoHS
COMPLIANT

REV.	ECN / DESCRIPTION	BY	DATE
A0	NEW	ZG.HU	2018.06.01

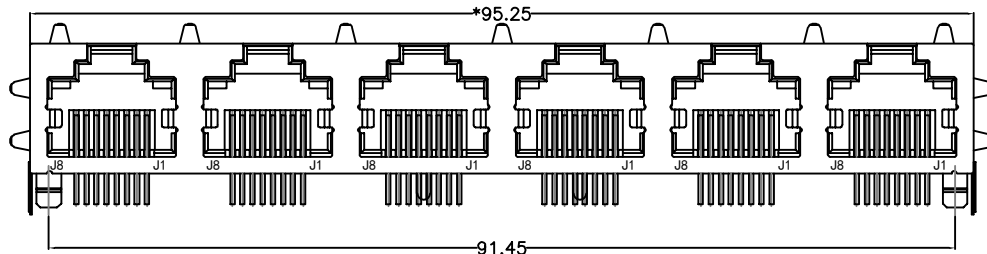

FRONT VIEW

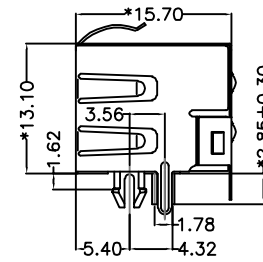

RIGHT SIDE VIEW

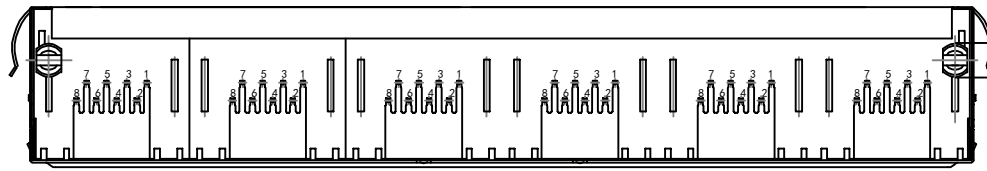

BOTTOM VIEW

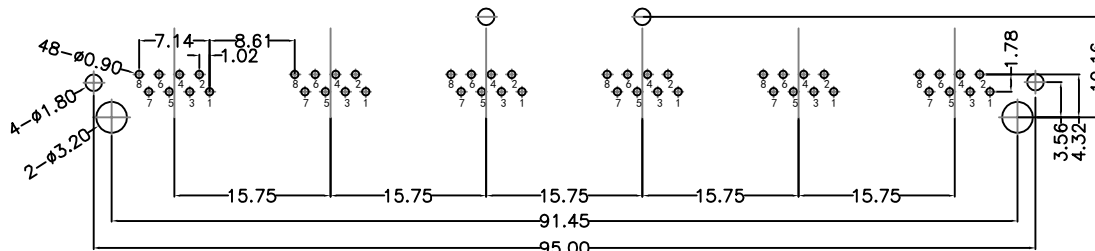

RECOMMENDED PCB LAYOUT
VIEWED FROM COMPONENT SIDE

MATERIAL:

HOUSING: PBT,UL94V-0,BLACK.
TERMINAL: PHOSPHOR BRONZE $\varnothing=0.46\text{MM}$.
G/FU" GOLD PLATING ON CONTACT AREA.
SHIELD: C2680,T=0.20MM,20 MIN NICKEL PLATING
ON ALL AREA.

MACHANICAL:

DURABILITY: 750 CYCLES MIN,12.5MM/MINUTE.
INSERTION FORCE: 2.2KG.F MAX.
RETENTION STRENGTH : 7.7KG.F BETWEEN JACK AND PLUG.
OPERATING TEMPERATURE: $-40^{\circ}\text{C}\sim+85^{\circ}\text{C}$.
STORAGE TEMPERATURE: $-40^{\circ}\text{C}\sim+85^{\circ}\text{C}$.
ALL CRITICAL DIMENSIONS WITH "*"

ELECTRICAL:

VOLTAGE: 125 VOLTS AC.
CURRENT RATING : 1.5AMP.
DIELECTRIC STRENGTH: 1000 VAC RMS 50HZ OR 60HZ,1MIN.
INSULATION RESISTANCE: 500 MEGA OHMS MIN. INITIAL
AFTER 500V DC FOR 1 MINUTE.
CONTACT RESISTANCE: SINGLE TERMINAL 30 MILLIOHMS MAX.
INITIAL 50 MILLIOHMS MAX. AFTER
DURABILITY TEST.

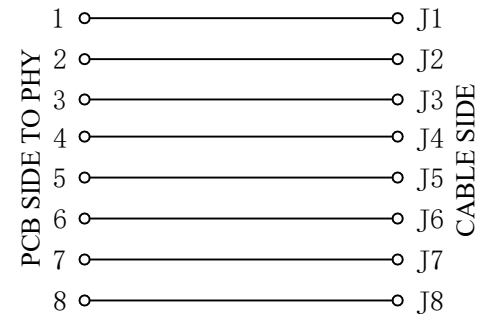

DGKYD

东莞市科优达电子科技有限公司
Dong Guan Ke You Da Electronic Tech.Co.,Ltd

ADD : No.1 LiHe Street,LiHeng Village, Qingxi town, DongGuan City, GuangDong Province
Tel:+86-0769-87334608; Fax:+86-0769-87847129 WWW.DGKYD.COM

TITLE:
56带屏蔽无灯 1X6 8P8C

PART NO.:
DGKYD561688HWA1D9Y1022

REMARK:

SIZE
A4

SACLE
1:1

SHEET
1/2

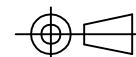

GENERAL TOLERANCES
UNLESS SPECIFIED

$x\pm 0.35$	$x^{\circ}\pm 3.0^{\circ}$
$.x\pm 0.30$	$.x^{\circ}\pm 2.0^{\circ}$
$.xx\pm 0.25$	$.xx^{\circ}\pm 1.5^{\circ}$
$.xxx\pm 0.10$	$.xxx^{\circ}\pm 1.0^{\circ}$

APPROVED BY:
JP.Gong

CHECKED BY:
TW.Xu

DESIGND BY:
ZG.Hu

REACH & RoHS
COMPLIANT

REV.	ECN / DESCRIPTION	BY	DATE
A0	NEW	ZG.HU	2018.06.01

Suggested Panel Opening:

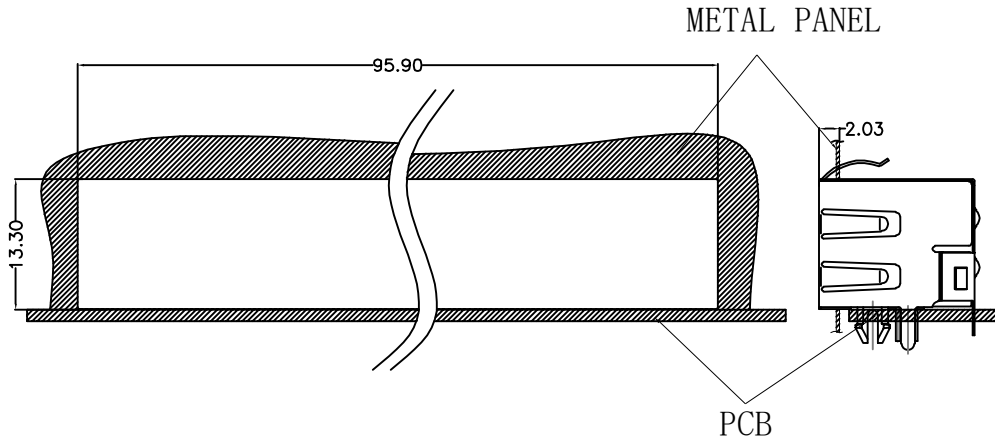

UNIT: mm / inch
Tolerances: $\pm 0.10 / 0.004$

Keep-Out Area (Component Side View):

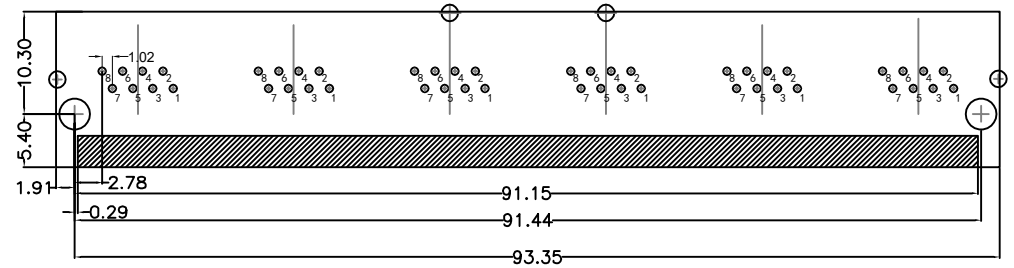

Plug In Side

UNIT: mm / inch
Tolerances: $\pm 0.10 / 0.004$

DGKYD

东莞市科优达电子科技有限公司
Dong Guan Ke You Da Electronic Tech.Co.,Ltd

ADD: No.1 LiHe Street, LiHeng Village, Qingxi town, DongGuan City, GuangDong Province
Tel: +86-0769-87334608; Fax: +86-0769-87847129 WWW.DGKYD.COM

TITLE:
56带屏蔽无灯 1X6 8P8C

PART NO.:
DGKYD561688HWA1D9Y1022

REMARK:

SIZE
A4

SACLE
1:1

SHEET
2/2

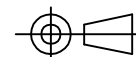

GENERAL TOLERANCES
UNLESS SPECIFIED

$x \pm 0.35$	$x^\circ \pm 3.0^\circ$
$.x \pm 0.30$	$.x^\circ \pm 2.0^\circ$
$.xx \pm 0.25$	$.xx^\circ \pm 1.5^\circ$
$.xxx \pm 0.10$	$.xxx^\circ \pm 1.0^\circ$

APPROVED BY:
JP.Gong

CHECKED BY:
TW.Xu

DESIGN BY:
ZG.Hu